

Assembly Instructions

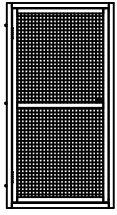

1PC

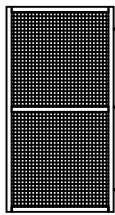

1PC

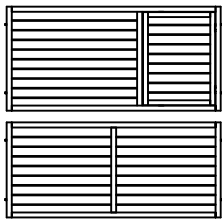

1PC

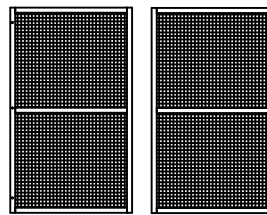

1PC

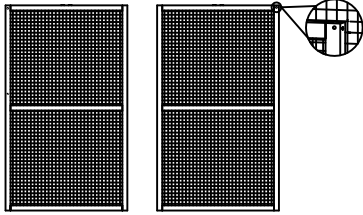

1PC

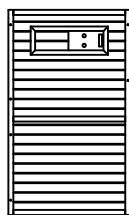

1PC

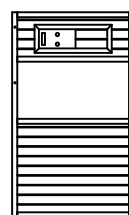

1PC

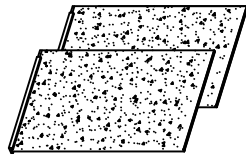
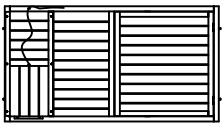

1PC

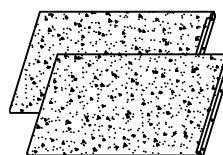

1PC

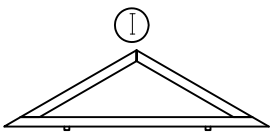

3PCS

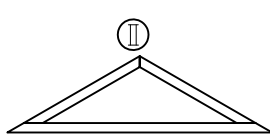

1PC

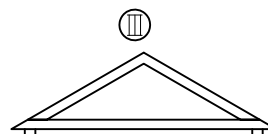

1PC

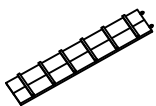

1PC

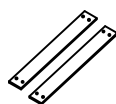

1PC

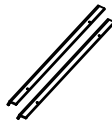

1PC



1PC



1PC



1PC



1PC



1PC

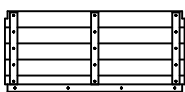

1PC



1PC

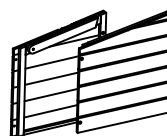

1PC



1PC



1PC



1PC

(A)  M3.5X50
40+2

(B)  M3.5X40
32+2

(C)  M3.5X25
22+2

(D)  M3.0X12
40+2

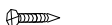
(E)  M3.0X30
1+1

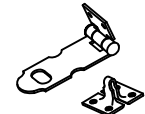

x1

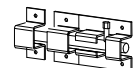

x5



x1



x1



x2



x1

STEP-01

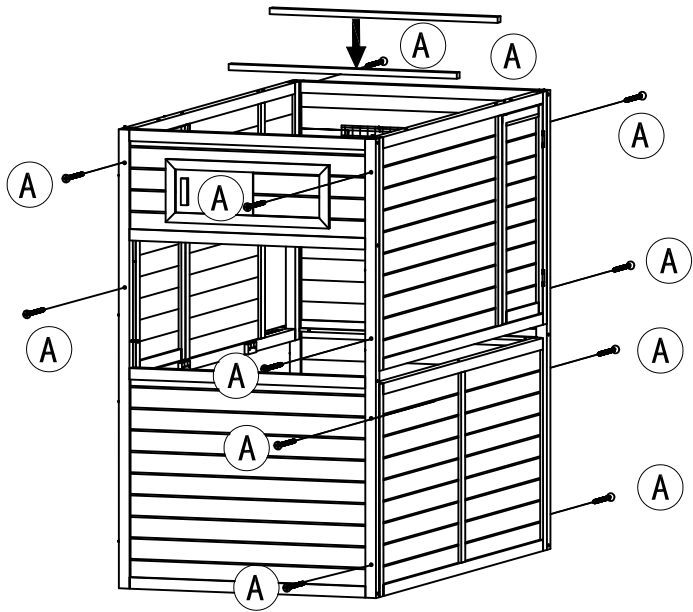

STEP-02

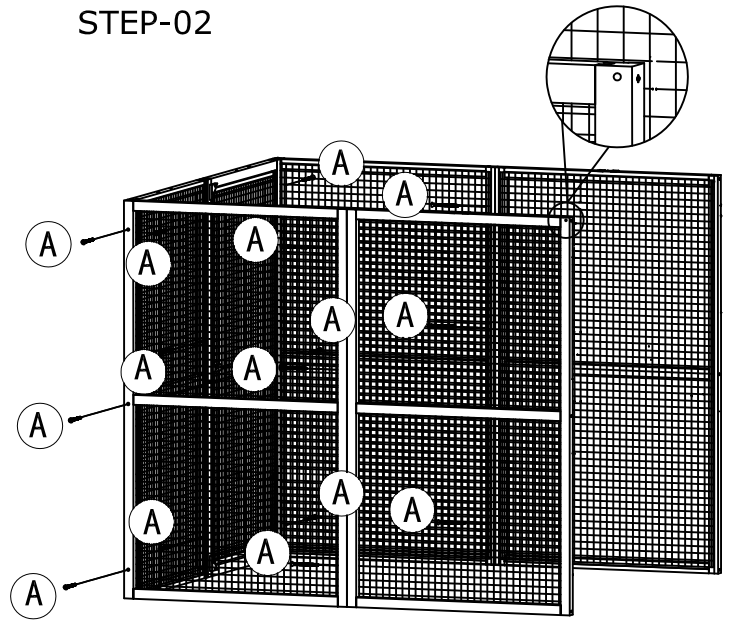

STEP-03

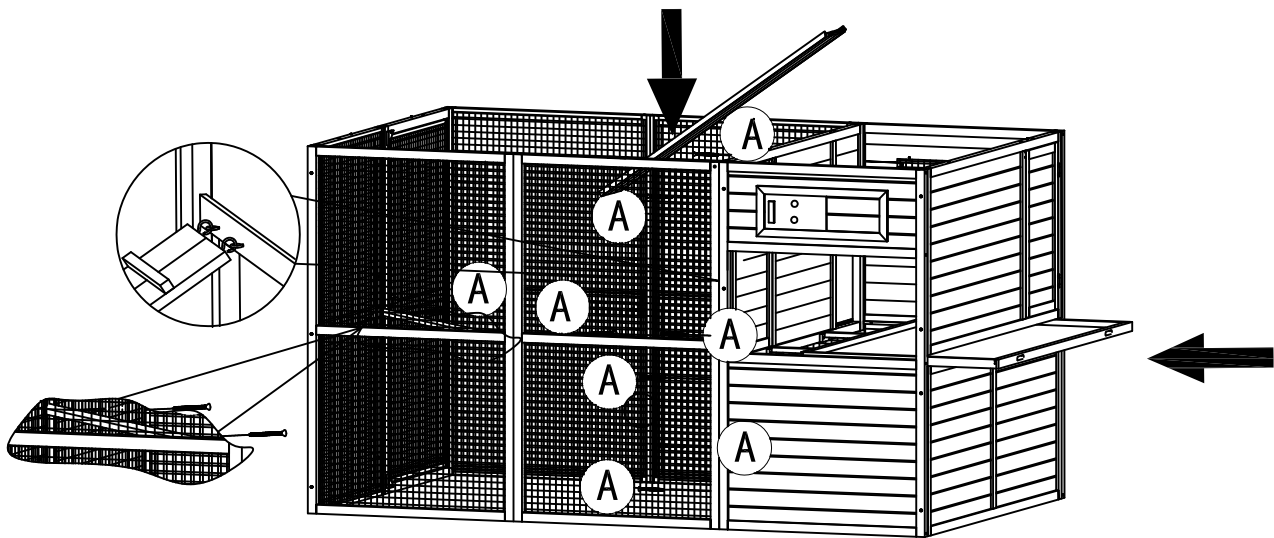

STEP-04

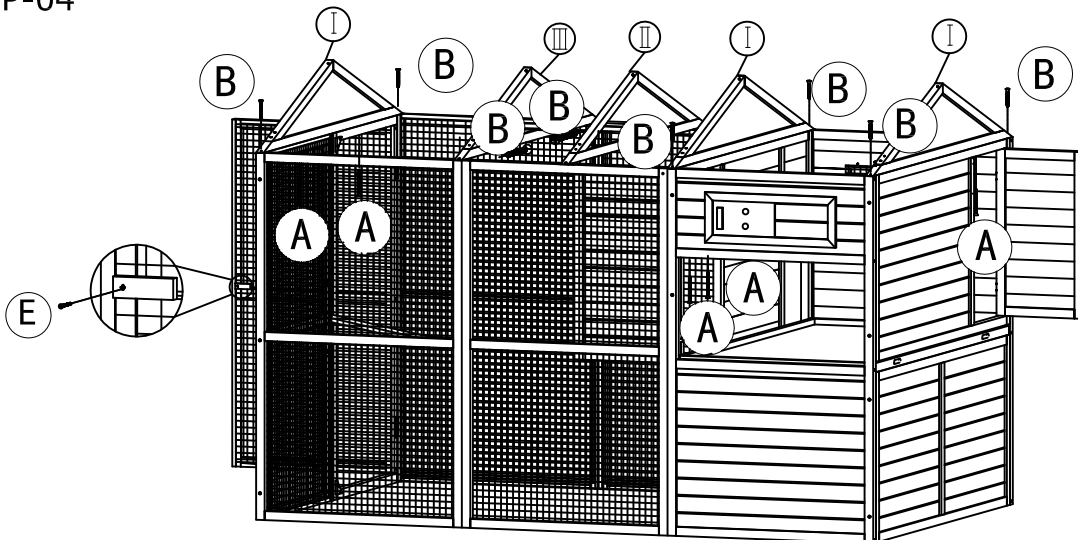

STEP-05

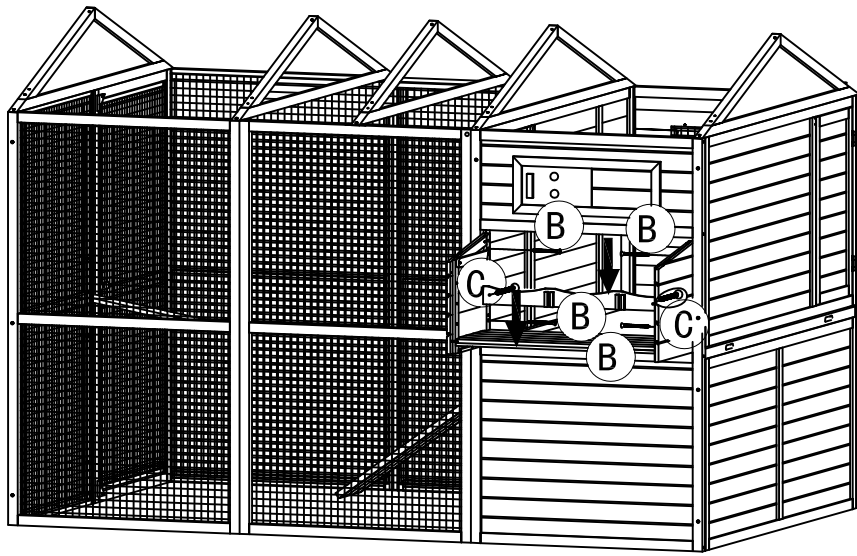

STEP-06

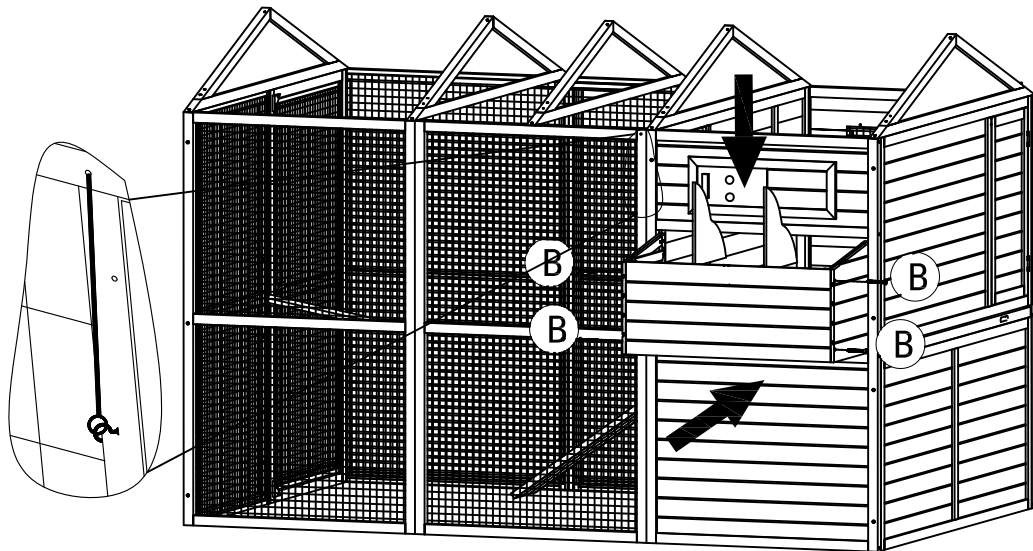

STEP-07

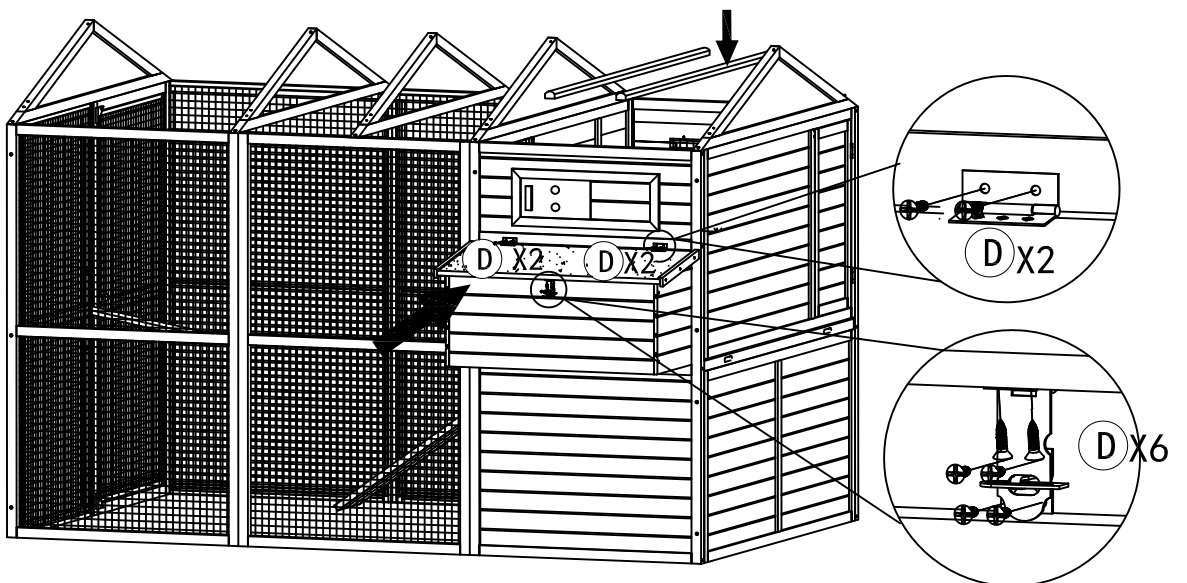

STEP-08

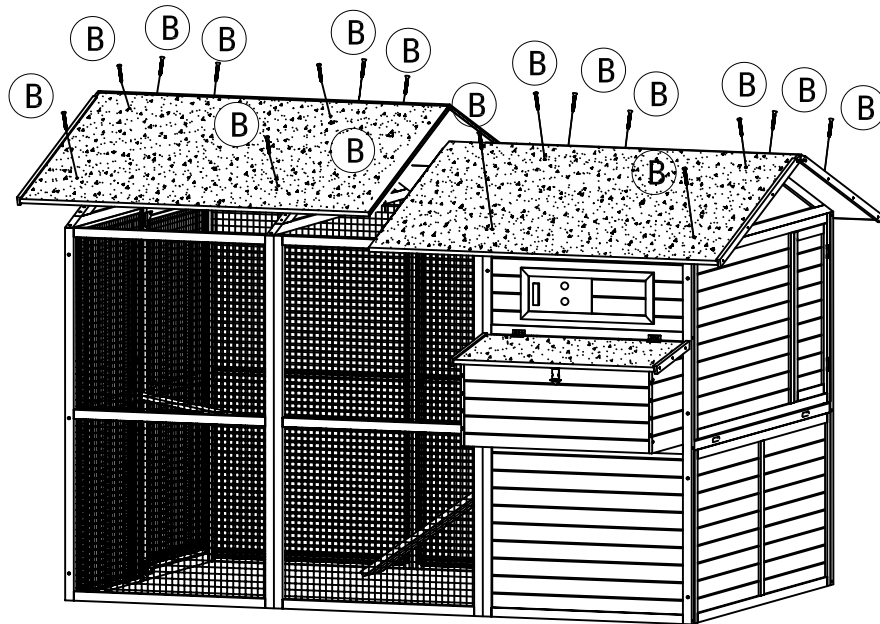

STEP-09

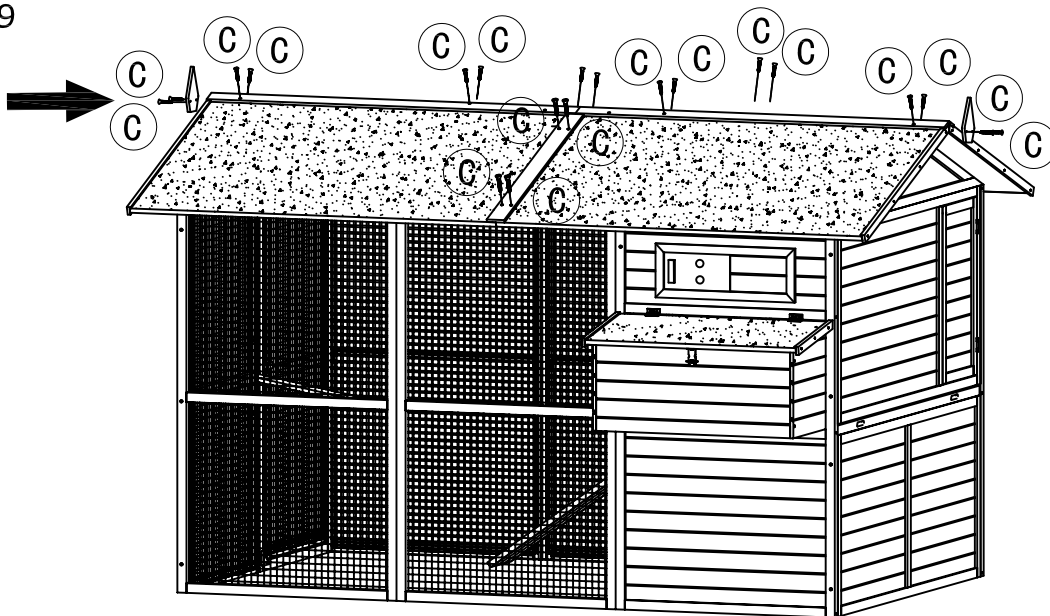

STEP-10

